

28N50Y

28 Amps,500 Volts N-CHANNEL Power MOSFET

FEATURE

- 28A,500V, $R_{DS(ON)MAX}=0.24\ \Omega$ @ $V_{GS}=10V/14A$
- Low gate charge
- Low C_{iss}
- Fast switching
- 100% avalanche tested
- Improved dv/dt capability

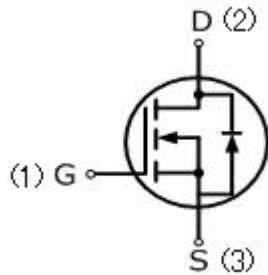

TO-247-3L

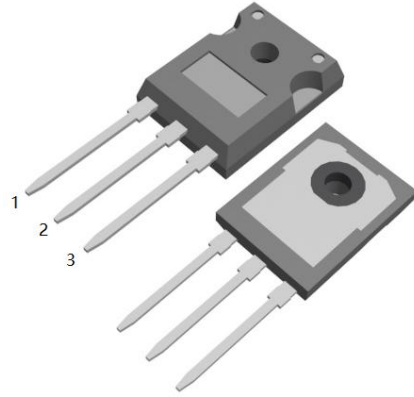

Absolute Maximum Ratings ($T_C=25^\circ\text{C}$, unless otherwise noted)

| Parameter | Symbol | 28N50Y | UNIT |
|--|----------------|-----------|------------------|
| Drain-Source Voltage | V_{DSS} | 500 | V |
| Gate-Source Voltage | V_{GS} | ± 30 | |
| Continuous Drain Current | I_D | 28 | A |
| Pulsed Drain Current(Note1) | I_{DM} | 112 | |
| Single Pulse Avalanche Energy (Note 2) | E_{AS} | 1323 | mJ |
| Reverse Diode dV/dt (Note 3) | dv/dt | 5 | V/ns |
| Operating Junction and Storage Temperature Range | T_J, T_{STG} | -55to+150 | $^\circ\text{C}$ |
| Maximum lead temperature for soldering purposes, 1/8" from case for 5 seconds | T_L | 260 | $^\circ\text{C}$ |

| Parameter | Symbol | 28N50Y | Units |
|--------------------------------------|---------------------------------|--------|---------------------------|
| Thermal resistance , Channel to Case | $R_{th(ch-c)}$ | 1.2 | $^\circ\text{C}/\text{W}$ |
| Maximum Power Dissipation | $T_C=25^\circ\text{C}$ P_D | 104 | W |

| Electrical Characteristics (T_c=25°C, unless otherwise noted) | | | | | | |
|--|---------------------|---|-----|-------|------|-------|
| Parameter | Symbol | Test Conditions | Min | Typ | Max | Units |
| Off Characteristics | | | | | | |
| Drain-Source Breakdown Voltage | BV _{DSS} | V _{GS} =0V, I _D =250uA | 500 | — | — | V |
| Zero Gate Voltage Drain Current | I _{DSS} | V _{DS} =500V, V _{GS} =0V | — | — | 1 | uA |
| Gate-Body Leakage Current, Forward | I _{GSSF} | V _{GS} =30V, V _{DS} =0V | — | — | 100 | nA |
| Gate-Body Leakage Current, Reverse | I _{GSSR} | V _{GS} =-30V, V _{DS} =0V | — | — | -100 | nA |
| On Characteristics | | | | | | |
| Gate-Source Threshold Voltage | V _{GS(th)} | V _{DS} =V _{GS} , I _D =250uA | 2.0 | — | 4.0 | V |
| Drain-Source On-State Resistance | R _{DS(on)} | V _{GS} =10V, I _D =14A | — | 0.17 | 0.24 | Ω |
| Dynamic Characteristics | | | | | | |
| Input Capacitance | C _{iss} | V _{DS} =25V, V _{GS} =0V, f=1.0MHZ | — | 4364 | — | pF |
| Output Capacitance | C _{oss} | | — | 311 | — | pF |
| Reverse Transfer Capacitance | C _{rss} | | — | 138 | — | pF |
| Switching Characteristics | | | | | | |
| Turn-On Delay Time | t _{d(on)} | V _{DD} =250V, I _D =28A, R _G =10Ω | — | 28.8 | — | ns |
| Turn-On Rise Time | t _r | | — | 5.6 | — | ns |
| Turn-Off Delay Time | t _{d(off)} | | — | 106.4 | — | ns |
| Turn-Off Fall Time | t _f | | — | 9.6 | — | ns |
| Total Gate Charge | Q _g | V _{DS} =400V, I _D =28A, V _{GS} =10V | — | 214 | — | nC |
| Gate-Source Charge | Q _{gs} | | — | 104 | — | nC |
| Gate-Drain Charge | Q _{gd} | | — | 19 | — | nC |
| Drain-Source Body Diode Characteristics and Maximum Ratings | | | | | | |
| Diode Forward Voltage | V _{SD} | I _S =1A, V _{GS} =0V | — | — | 1.2 | V |

Notes

1. Repetitive Rating: pulse width limited by maximum junction temperature.
2. V_{DD}=50V, L=10mH, R_g=25 Ω, starting T_J=25°C.
3. Pulse width ≤ 300us; duty cycle ≤ 2%.

RATING AND CHARACTERISTIC CURVES



Peak Diode Recovery dv/dt Test Circuit



Peak Diode Recovery dv/dt Waveforms



Switching Test Circuit



Switching Waveforms



Gate Charge Test Circuit



Gate Charge Waveform



Unclamped Inductive Switching Test Circuit



Unclamped Inductive Switching Waveforms

RATING AND CHARACTERISTIC CURVES

Figure.1 Typical Output Characteristics

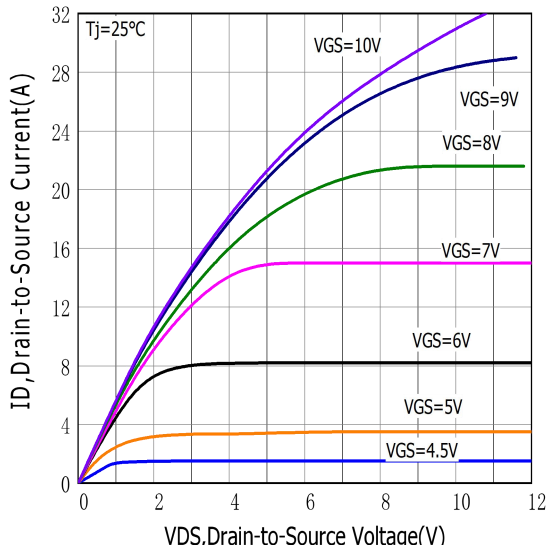

Figure.2 Typical Gate Charge vs Gate to Source Voltage

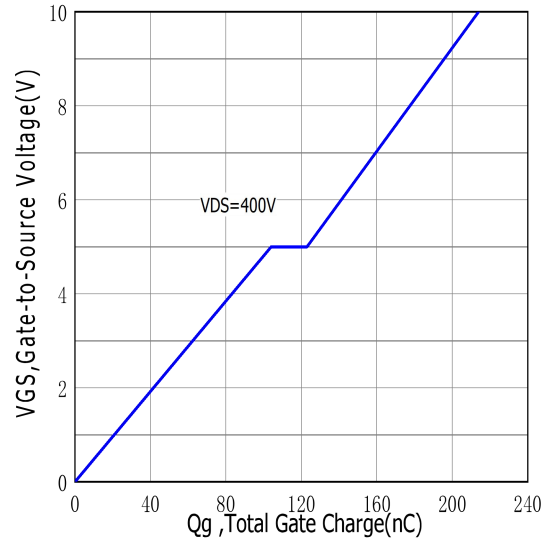

Figure.3 Typical Body Diode Transfer Characteristics

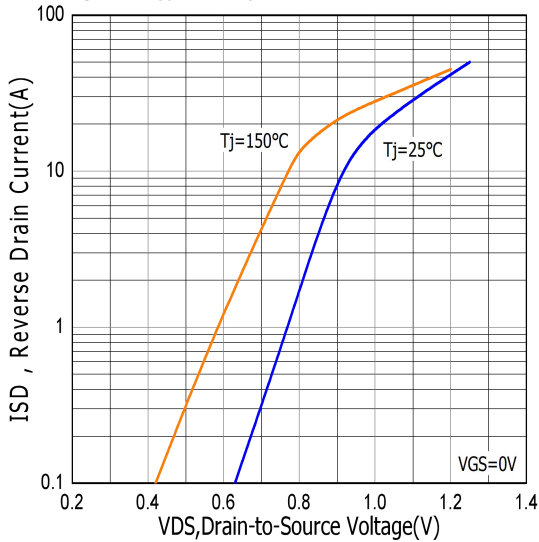

Figure.4 Typical Capacitance vs Drain to Source Voltage

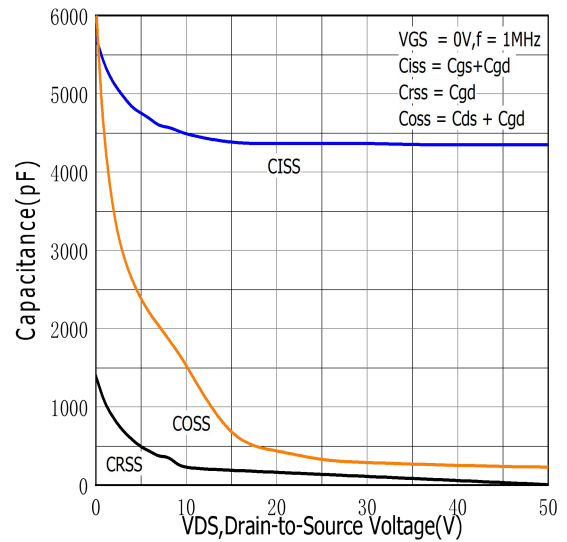

Figure.5 Typical Breakdown Voltage vs Junction Temperature

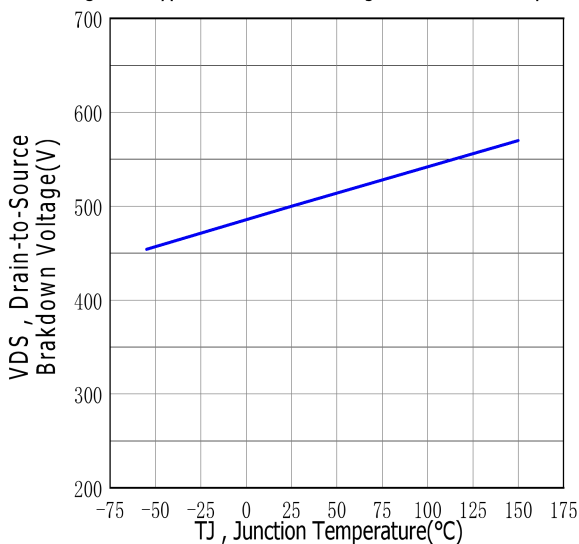

Figure.6 Typical Drain to Source on Resistance vs Junction Temperature

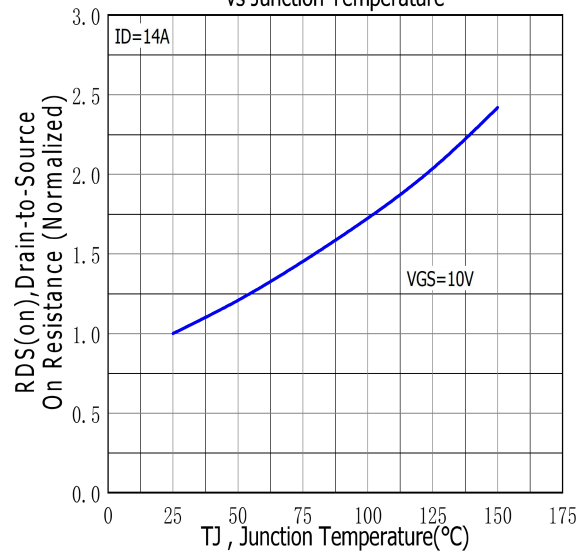

Figure.7 Maximum Forward Bias Safe Operating Area

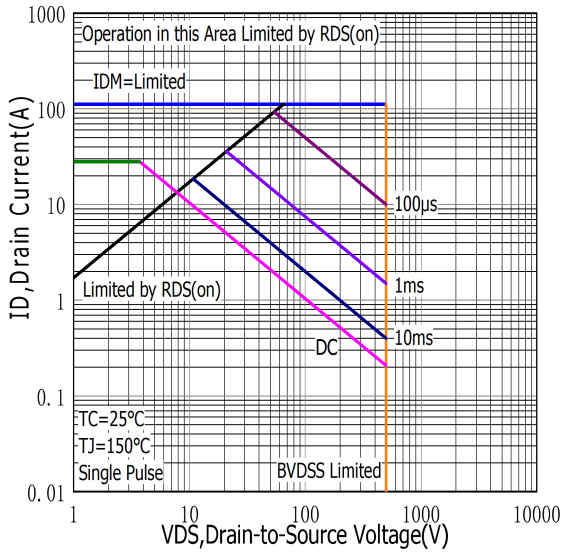

Figure.8 Typical Drain to Source ON Resistance vs Drain Current

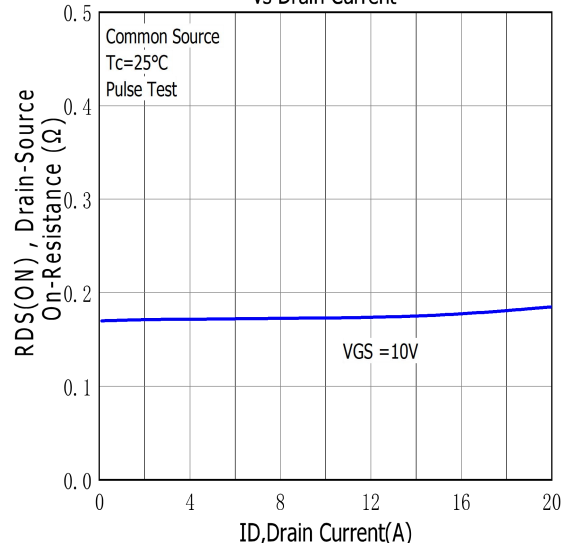

Figure.9 Maximum EAS vs Channel Temperature

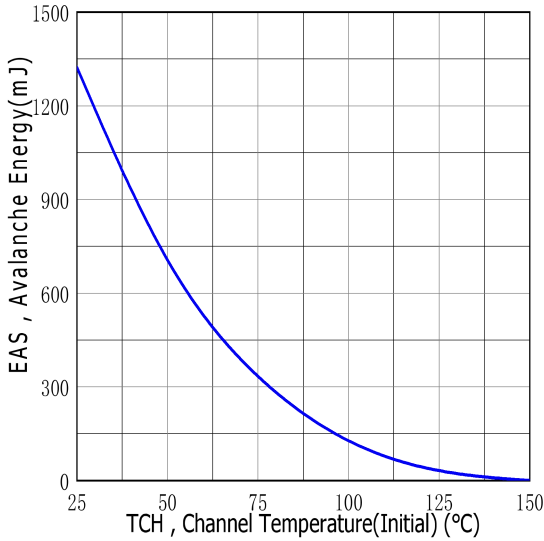

Figure.10 Typical Threshold Voltage vs Case Temperature

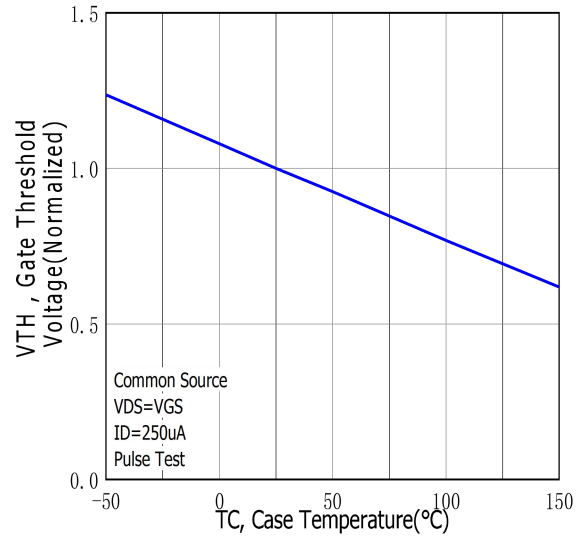

Figure.11 Maximum Effective Thermal Impedance, Junction to Case

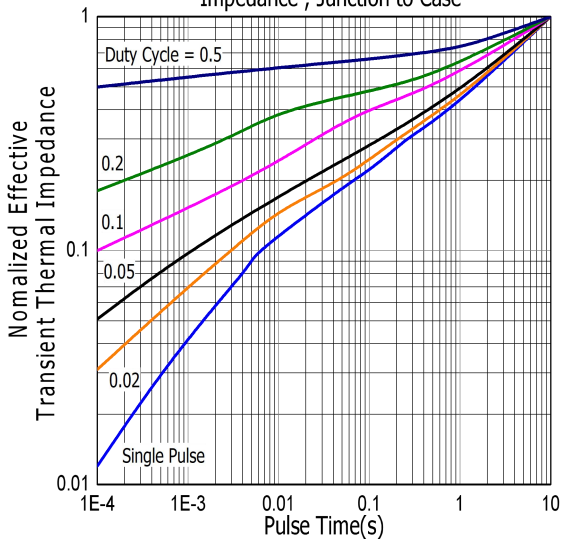
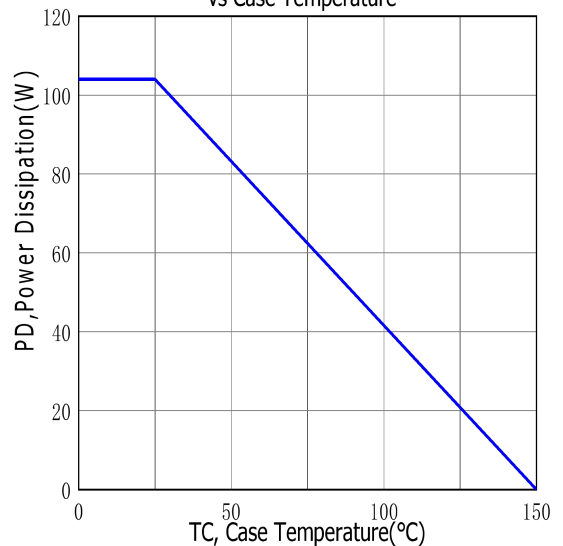
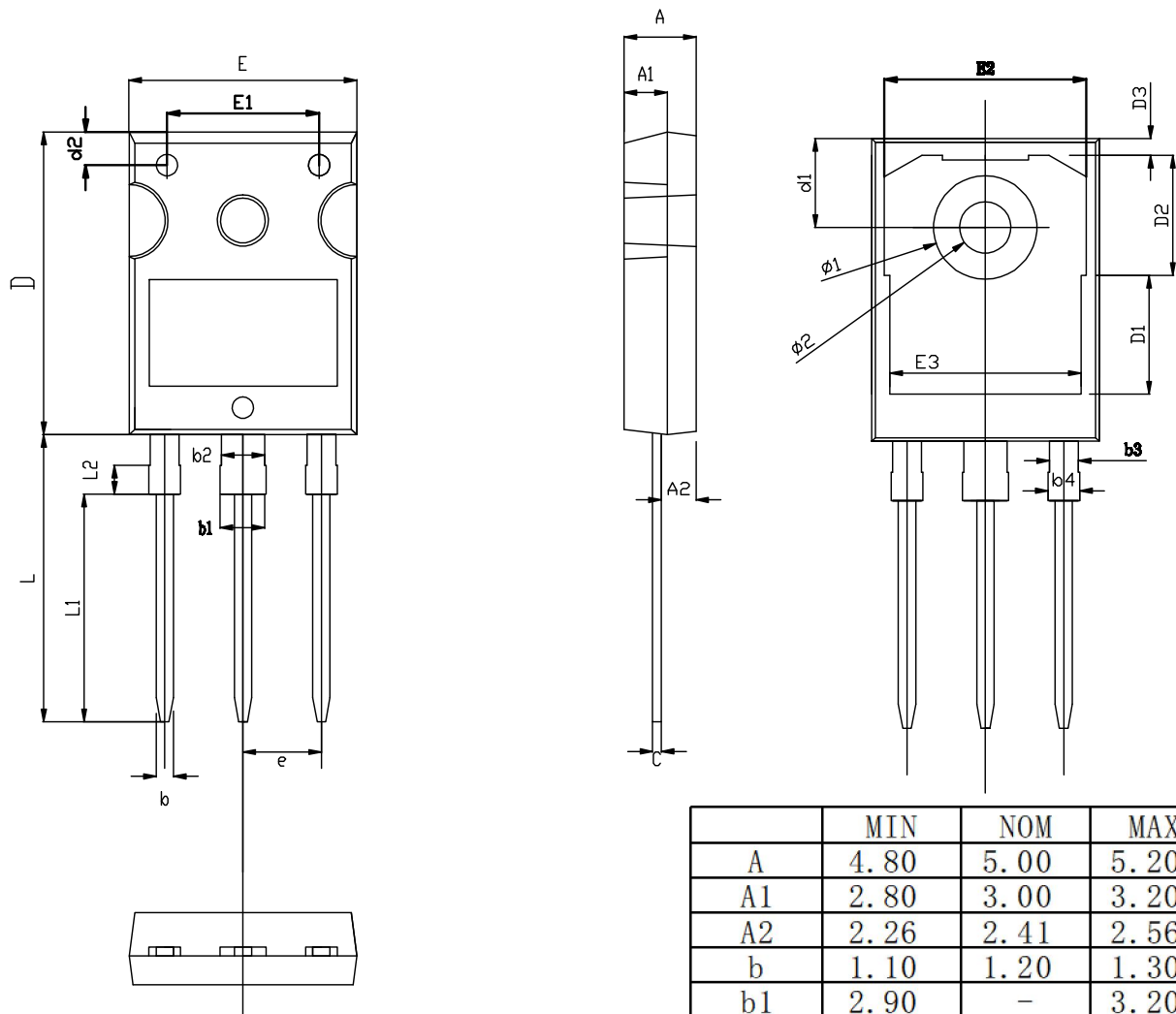

Figure.12 Maximum Power Dissipation vs Case Temperature



TO-247-3L PACKAGE OUTLINE



RECOMMENDED LAND PATTERN

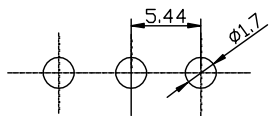

UNIT: mm

| | MIN | NOM | MAX |
|----|-------|-------|-------|
| A | 4.80 | 5.00 | 5.20 |
| A1 | 2.80 | 3.00 | 3.20 |
| A2 | 2.26 | 2.41 | 2.56 |
| b | 1.10 | 1.20 | 1.30 |
| b1 | 2.90 | - | 3.20 |
| b2 | 2.90 | 3.00 | 3.10 |
| b3 | 1.90 | 2.00 | 2.10 |
| b4 | 2.00 | - | 2.20 |
| c | 0.50 | 0.60 | 0.70 |
| D | 20.80 | 21.00 | 21.20 |
| D1 | | 8.23 | |
| D2 | | 8.32 | |
| D3 | | 1.17 | |
| d1 | 6.00 | 6.15 | 6.30 |
| d2 | 2.20 | 2.30 | 2.40 |
| E | 15.60 | 15.80 | 16.00 |
| E1 | | 10.50 | |
| E2 | | 14.02 | |
| E3 | | 13.50 | |
| e | 5.34 | 5.44 | 5.54 |
| L | 19.72 | 19.92 | 20.12 |
| L1 | | 15.79 | |
| L2 | | 1.98 | |
| ø1 | 7.10 | 7.19 | 7.30 |
| ø2 | 3.50 | 3.60 | 3.70 |